

DRAWMER



MX40

QUAD PUNCH GATE

OPERATORS MANUAL

CONTENTS

SAFETY CONSIDERATIONS	page 3
INSTALLATION	page 3
INTRODUCTION	page 4
• Audio Connections	page 4
• Power Connection	page 5
CONTROL DESCRIPTIONS	page 6
• Punch Gate	page 6
• Key Filter	page 7
• Linking	page 7
OPERATION	page 8
IF A FAULT DEVELOPS	page 12
CONTACTING DRAWMER	page 12
TECHNICAL SPECIFICATION	page 13
BLOCK DIAGRAM	page 14
SESSION RECALL	page 15

COPYRIGHT

This manual is copyrighted © 2011 by Drawmer Electronics, Ltd. With all rights reserved. Under copyright laws, this manual may not be duplicated in whole or in part without the written consent of Drawmer.

ONE YEAR LIMITED WARRANTY

Drawmer Electronics Ltd., warrants the MX40 Quad Punch Gate to conform substantially to the specifications of this manual for a period of one year from the original date of purchase when used in accordance with the specifications detailed in this manual. In the case of a valid warranty claim, your sole and exclusive remedy and Drawmer's entire liability under any theory of liability will be to, at Drawmer's discretion, repair or replace the product without charge, or, if not possible, to refund the purchase price to you. This warranty is not transferable. It applies only to the original purchaser of the product.

For warranty service please call your local Drawmer dealer. Alternatively call Drawmer Electronics Ltd. at +44 (0)1709 527574. Then ship the defective product, with transportation and insurance charges pre-paid, to Drawmer Electronics Ltd., Coleman Street, Parkgate, Rotherham, S62 6EL UK. Write the RA number in large letters in a prominent position on the shipping box. Enclose your name, address, telephone number, copy of the original sales invoice and a detailed description of the problem. Drawmer will not accept responsibility for loss or damage during transit.

This warranty is void if the product has been damaged by misuse, modification or unauthorised repair.

THIS WARRANTY IS IN LIEU OF ALL WARRANTIES, WHETHER ORAL OR WRITTEN, EXPRESSED, IMPLIED OR STATUTORY. DRAWMER MAKES NO OTHER WARRANTY EITHER EXPRESS OR IMPLIED, INCLUDING, WITHOUT LIMITATION, ANY IMPLIED WARRANTIES OF MERCHANTABILITY, FITNESS FOR A PARTICULAR PURPOSE, OR NON-INFRINGEMENT. PURCHASER'S SOLE AND EXCLUSIVE REMEDY UNDER THIS WARRANTY SHALL BE REPAIR OR REPLACEMENT AS SPECIFIED HEREIN.

IN NO EVENT WILL DRAWMER ELECTRONICS LTD. BE LIABLE FOR ANY DIRECT, INDIRECT, SPECIAL, INCIDENTAL OR CONSEQUENTIAL DAMAGES RESULTING FROM ANY DEFECT IN THE PRODUCT, INCLUDING LOST PROFITS, DAMAGE TO PROPERTY, AND, TO THE EXTENT PERMITTED BY LAW, DAMAGE FOR PERSONAL INJURY, EVEN IF DRAWMER HAS BEEN ADVISED OF THE POSSIBILITY OF SUCH DAMAGES.

Some states and specific countries do not allow the exclusion of implied warranties or limitations on how long an implied warranty may last, so the above limitations may not apply to you. This warranty gives you specific legal rights. You may have additional rights that vary from state to state, and country to country.

In the interests of product development, Drawmer reserve the right to modify or improve specifications of this product at any time, without prior notice.

DRAWMER MX40

Quad Punch Gate



SAFETY CONSIDERATIONS



CAUTION - MAINS FUSE

TO REDUCE THE RISK OF FIRE REPLACE THE MAINS FUSE ONLY WITH THE SAME TYPE, WHICH MUST BE A CLASS 3, 230 VOLT, TIME DELAY TYPE, RATED AT 63mA WHERE THE MAINS INPUT VOLTAGE SWITCH IS SET TO 230 VOLTS AC. AND 125mA WHERE THE MAINS INPUT VOLTAGE IS 115 VOLTS AC.

ALL FUSES MUST COMPLY WITH IEC 127-2.
THE FUSE BODY SIZE IS 20mm x 5mm.

CAUTION - MAINS CABLE

DO NOT ATTEMPT TO CHANGE OR TAMPER WITH THE SUPPLIED MAINS CABLE.

CAUTION - SERVICING

DO NOT PERFORM ANY SERVICING. REFER ALL SERVICING TO QUALIFIED SERVICE PERSONNEL.

WARNING

TO REDUCE THE RISK OF FIRE OR ELECTRIC SHOCK DO NOT EXPOSE THIS EQUIPMENT TO RAIN OR MOISTURE.



INSTALLATION

The MX40 is designed for standard 19" rack mounting and occupies 1U of rack space. Avoid mounting the unit directly above power amplifiers or power supplies that radiate significant amounts of heat. **Always** connect the mains earth to the unit. Use fibre or plastic washers to prevent the front panel becoming marked by the mounting bolts.

INTRODUCTION

The MX40 is a highly flexible but compact quad Gate suitable for a wide range of professional applications including studio, live sound and audio installations. The input and output connections are electronically balanced on XLR connectors and low-distortion VCAs are used to maintain the highest possible signal quality. Although optimised for +4dBu operation, the MX40 will work equally well with systems operating at the -10dBu standard.

Any Noise Gate considerably improves the sound of percussive instruments by producing fast leading edges to the signal and then shutting off after a pre-determined time. The combination of this fast rising edge, and the silence which follows the gated signal, creates a dramatic improvement to the original signal.

Drawmer pioneered the frequency conscious gating common to many noise gate clones now available in audio processing equipment. The MX40 has a new spin on this feature where both controls have been amalgamated into a single intuitive control, of course with a Key Listen facility. This allows fast and simple setup of frequency selective triggering where unwanted signals are prevented from triggering the gate.

AUDIO CONNECTIONS

Input and Output audio connections are provided via balanced XLRs at a level of +4dBu. This applies to both inputs and outputs. The wiring convention being:

Pin 1 Ground; Pin 2 Hot(+); and Pin 3 Cold(-).

For use with unbalanced systems, the Cold pin 3 must be grounded at both input and output inside the XLR connectors. For connection to a patch bay, input sockets should be wired 'fully normalised'.

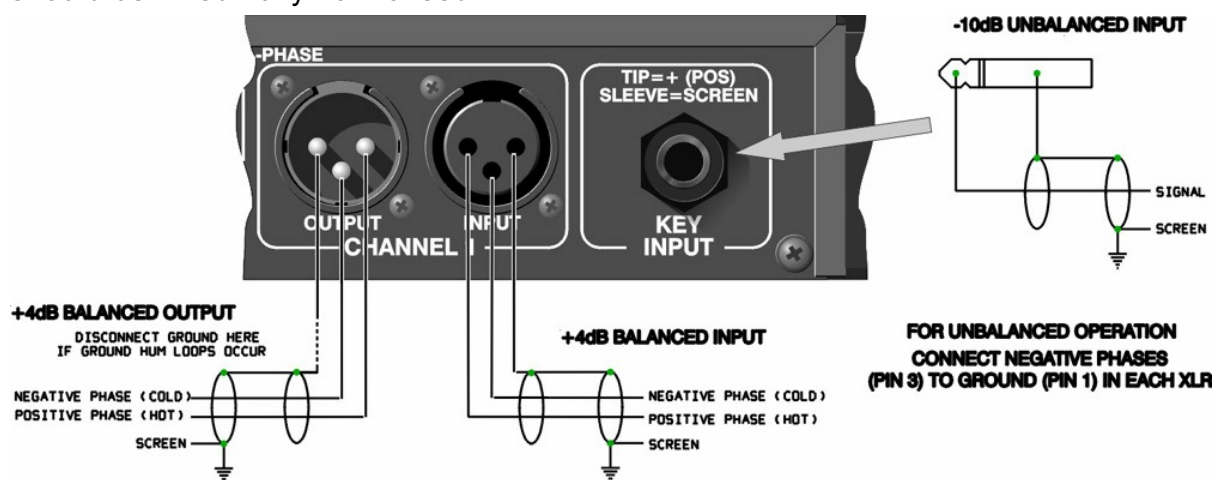

The key input is an unbalanced ¼" (TRS) jack socket. For connection to a patch bay this socket should be wired 'fully normalised' to prevent erratic triggering.

Interference: If the unit is to be used where it may be exposed to high levels of disturbance such as found close to a TV or radio transmitter, we advise that the unit is operated in a balanced configuration. The screens of the signal cables should be connected to the chassis connection on the XLR connector as opposed to connecting to pin 1. The MX40 conforms to the EMC standards.

Ground Loops: If ground loop problems are encountered, **never** disconnect the mains earth, instead, try disconnecting the signal screen on one end of each of the cables connecting the outputs of the MX40 to the patchbay. If such measures are necessary, balanced operation is recommended.

POWER CONNECTION

If, for some reason, the unit is to be operated at a mains input voltage which is different to that as supplied, the following procedure must be carried out by a **qualified technical engineer**.

- 1: Disconnect the unit from the mains.
- 2: Using a number 1 size pozidrive screwdriver, remove the seven self-tapping screws that retain the top cover.

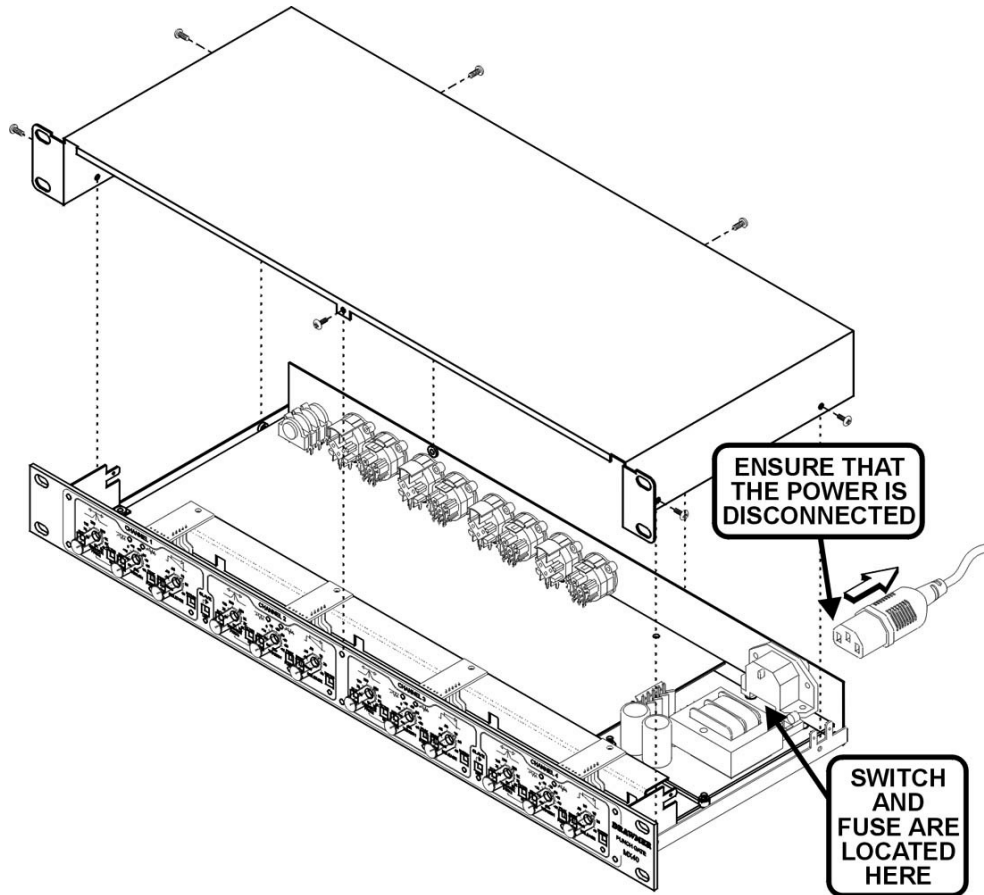

Accessing the internal power switch and fuse

3. Set the voltage rating and replace the fuse.
4. Replace the cover.

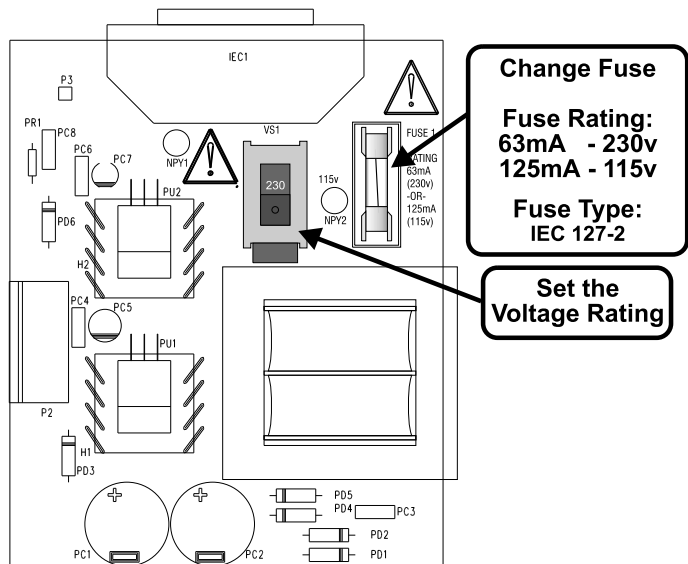



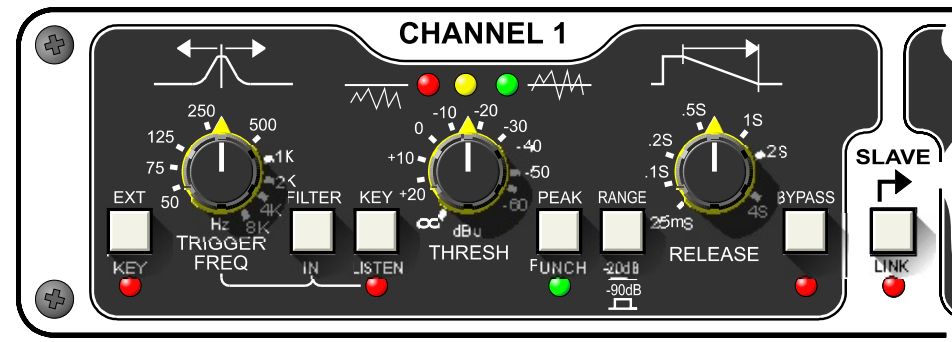

CONTROL DESCRIPTION

The four channels of the MX40 are virtually identical and may be used completely independently or linked as pairs for stereo-channel operation. In the linked stereo mode, only the controls of channel 1 and channel 3 are functional and serve as master controls, though all the channel Bypass, Key Listen and Range switches remain independent. When linked, the control signal is derived only from the programme material present at the input of the master channel.



- Threshold**  -60dB to greater than +20dB
Sets the level at which the gate opens.
- Display** The famous Drawmer “traffic light” display shows gate status.



Gate Closed Hold Time Gate Open
- Release**  25mS to 4S.
Additionally some envelope hold time is built into the system which varies with the release time setting.
- Peak Punch**  Peak Punch is a dynamic feature which accelerates the leading edge as the gated signal opens, adding more than 6dB of gain for approximately 10mS with proprietary release characteristics.
- Range**  Determines how much gain reduction is applied when the gate is fully closed. A setting of -90dB effectively silences the signal completely, while the -20dB setting will still allow an attenuated version of the signal to pass through. We recommend this switch is left in the -90dB (out) position.
For signals with a high levels of background noise, the very fact of closing down to -90dB can be disconcertingly noticeable. In such cases the -20dB switch setting can achieve better results.
Note: This control is active on both channels, even in stereo linked operation.
- Bypass**  The Bypass position routes the input signal to the output with no processing.
Note: These switches are independent of any linking and will only bypass their respective channel.

Key Filter

Key Listen



In normal operation, the filter only affects the way the MX40 responds to the incoming programme material - it does not have any direct effect on the output signal, but when Key listen is enabled, the effect of the key filter on the programme material is heard at the output. These switches are independent of any linking and enable Key Listen of only their respective channel.

Trigger Freq.



50Hz to 8KHz with a width (or 'Q') of one octave. Use Key Filter to hear the filter, and tune into the loudest part of the trigger source sound.

Ext Key



When in the Ext(ernal) Key position, the LED will be illuminated and the common external key source buss is used to control the gate action, making it possible to gate one sound according to the signal dynamics of another, independent signal. If released, this switch causes the gate to respond to the dynamics of the signal present at the channel signal input socket. If no Ext Key input is plugged into the unit, then Channel 1's audio signal becomes the default trigger source available to all channels selected by the Key Input.

Filter In



This switch is used to enable the control of the key trigger filter. It is normal that this switch would be selected except where the internal (or external) control signal has a broad spectrum of audio information that the narrow pass-band of the filter would otherwise restrict trigger information.

Linking

Slave Link



The Link buttons are located between odd/even channels, and when depressed, cause the channel on the right (channel 2 or 4) to be controlled by the left-hand channel (channel 1 or 3). In linked mode, the red status LED beneath the Slave Link switch will be illuminated, and the Ext Key and Peak Punch LEDs of the slave channel will be extinguished. This indicates which controls of the slave channel are still operative.

OPERATION

Use the following diagrams as a guide to using the MX40.

Typical Setup

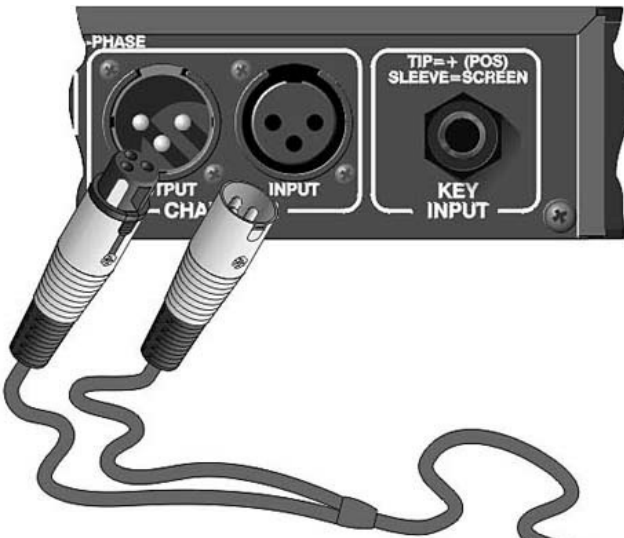

Key	
	Set the knob to the position shown.
	Not Used
<input type="checkbox"/>	Switch is Out
<input checked="" type="checkbox"/>	Switch is In
<input checked="" type="checkbox"/>	Set to User Preference

Operation: Gating a Snare Drum

1.5 kHz Input Level Dependant 50 ms

Operation: Gating Toms

~375 Hz Input Level Dependant 0.1 S

Operation: Gating Vocals

Filter Out Input Level Dependant 0.5 S

Ch 1 Signal

Triggering a Bass Guitar from a Kick Drum

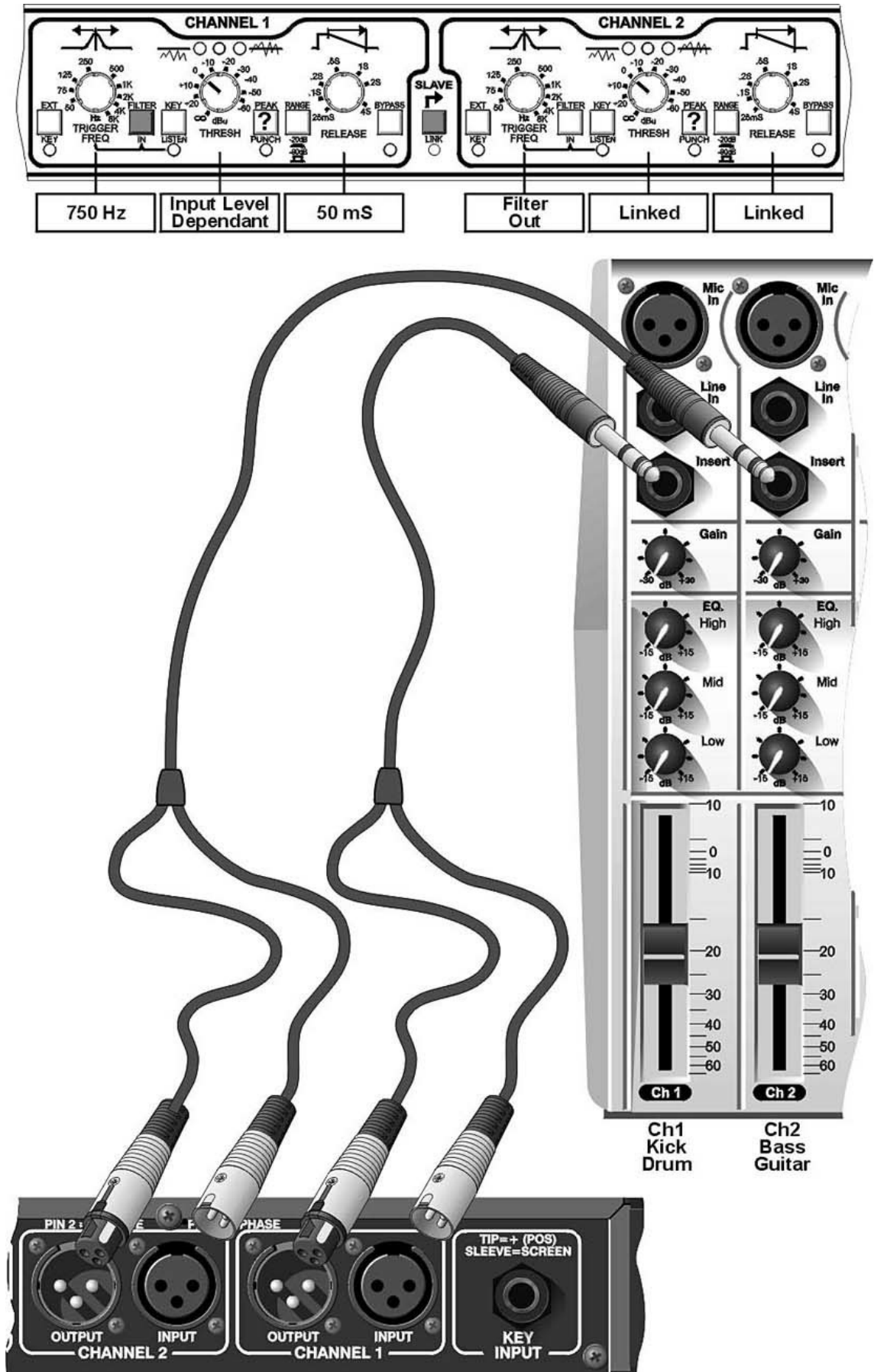

Adding Depth to a Kick Drum

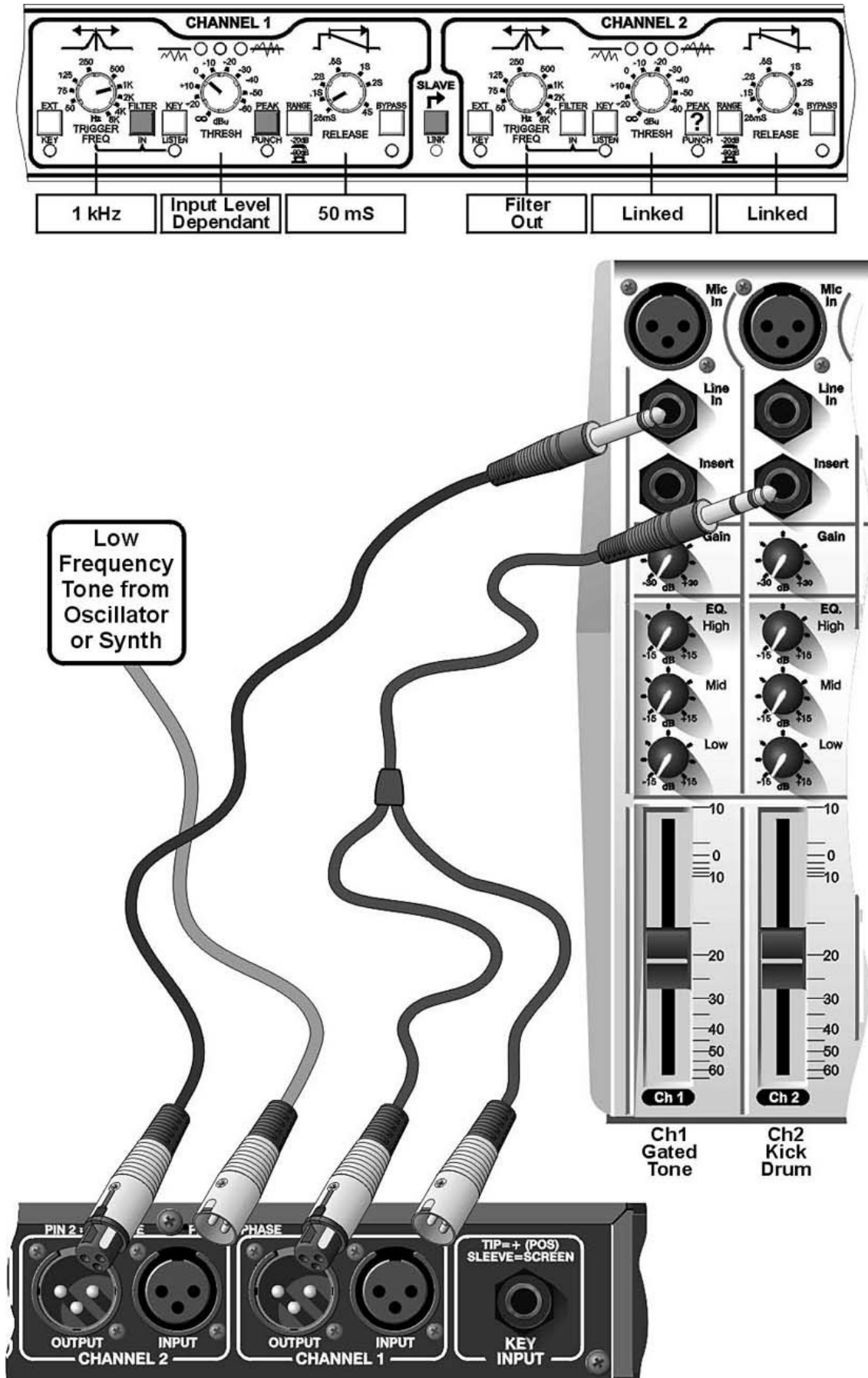

Gating all Four Channels using Channel 1 as the Trigger

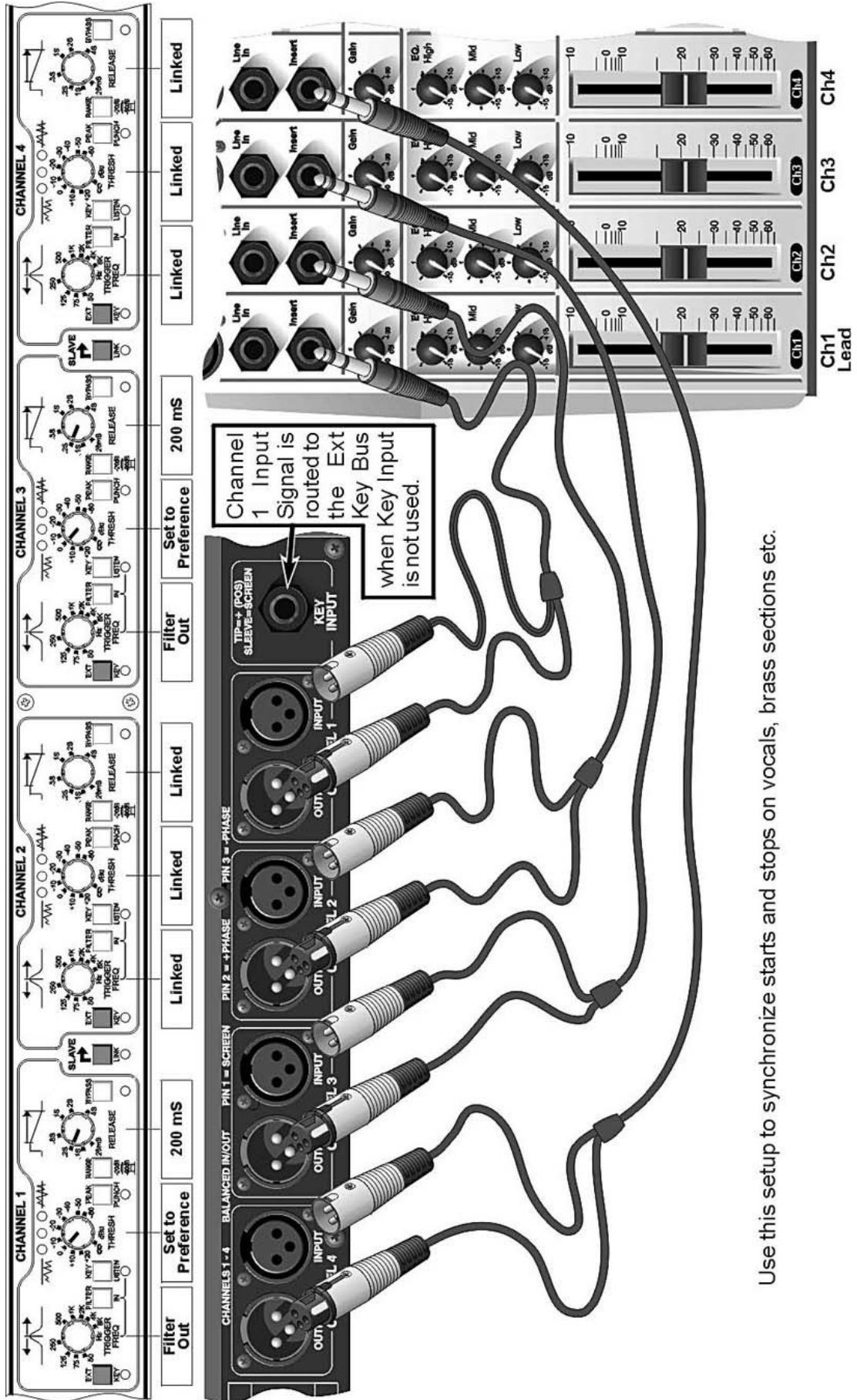

Use this setup to synchronize starts and stops on vocals, brass sections etc.

IF A FAULT DEVELOPS

For warranty service please call Drawmer Electronics Ltd. Or their nearest authorised service facility, giving full details of the difficulty. On receipt of this information, service or shipping instructions will be forwarded to you. No equipment should be returned under the warranty without prior consent from Drawmer or their authorised representative.

For service claims under the warranty agreement a service Returns Authorisation (RA) number will be given. Write this RA number in large letters in a prominent position on the shipping box. Enclose your name, address, telephone number, copy of the original sales invoice and a detailed description of the problem.

Authorised returns should be prepaid and must be insured. All Drawmer products are packaged in specially designed containers for protection. If the unit is to be returned, the original container must be used. If this container is not available, then the equipment should be packaged in substantial shock-proof material, capable of withstanding the handling for the transit.

CONTACTING DRAWMER

Drawmer Electronics Ltd., will be pleased to answer all application questions to enhance your usage of this equipment. Please address correspondence to:

Drawmer (Technical Help line) : Coleman St.: Parkgate : Rotherham : S62 6EL : UK

or, E-mail us on :

tech@drawmer.com

Drawmer dealers, Authorised service departments and other contact information can be obtained from our web pages on <http://www.drawmer.com>

TECHNICAL SPECIFICATIONS

(All measurements reference +4dBu operating level)

INPUT IMPEDANCE	20K Ω (Balanced)
KEY INPUT IMPEDANCE	20K Ω (Unbalanced)
INPUT CMR	>-40dB
MAXIMUM INPUT LEVEL	+21dBu
MAXIMUM KEY INPUT LEVEL	+21dBu
OUTPUT IMPEDANCE	50 Ω (Balanced)
MAXIMUM OUTPUT LEVEL	+21dBu
BANDWIDTH	<10Hz to 22KHz -1dB

NOISE	Wideband (worst case)	22Hz - 22KHz
AV	-100dB	-105dB
RMS	-104dB	-106dB

DISTORTION	100Hz	1KHz	10KHz
Gate Open with +4dBu input	< 0.04%	< 0.02%	< 0.04%

POWER REQUIREMENTS	115Volt or 230Volt at 50-60Hz, 15 Watts
FUSE RATING	63mA for 230Volt, 125mA for 115Volt CONFORMING TO IEC 127-2
FUSE TYPE	20mm x 5mm, Class 3 Slo-Blo, 250Volt working
CASE SIZE	482mm (w) x 44mm (h) x 175mm (d)
WEIGHT (incl packaging)	3.7 Kgs

BLOCK DIAGRAM

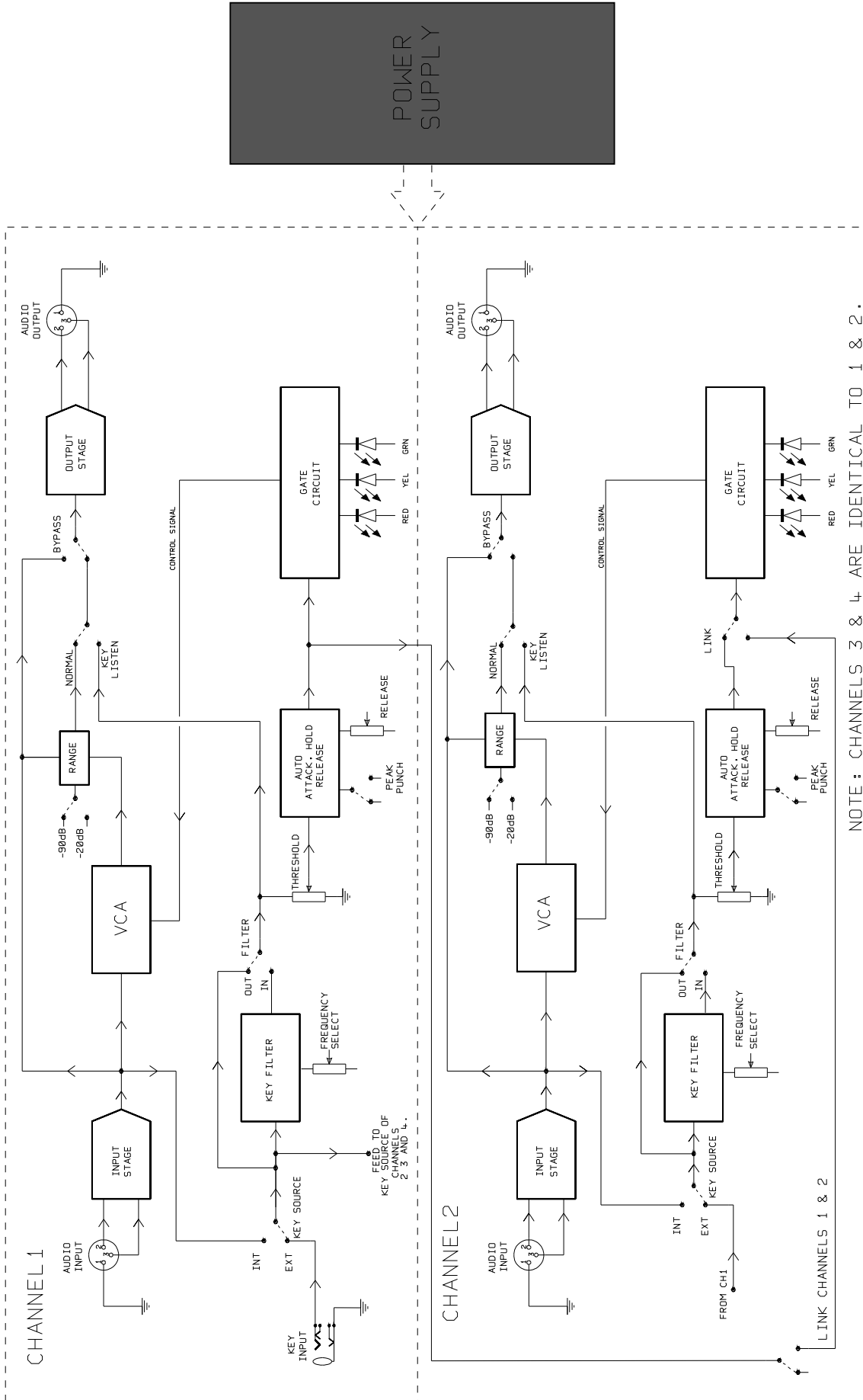

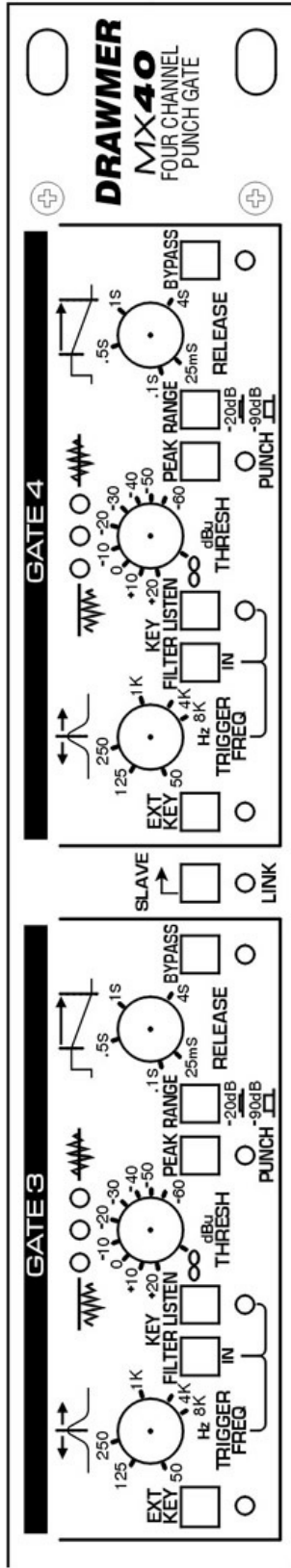
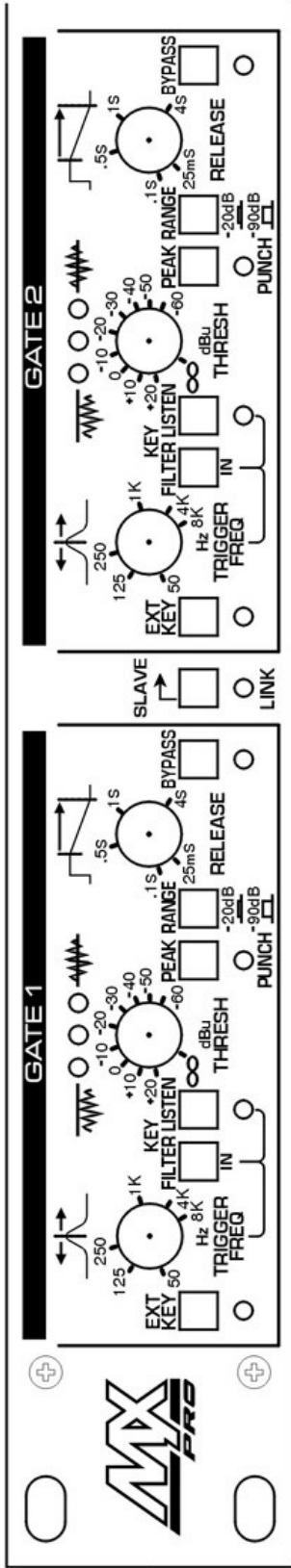

DRAWNER MX40 Session Recall	Session No.
	Date
	Artist
	Tape Location
DRAWNER ELECTRONICS LTD ~ Coleman Street Rotherham ~ S. Yorkshire ~ UK	
© COPYRIGHT DRAWNER ELECTRONICS LTD 2011	

